

Dimensions

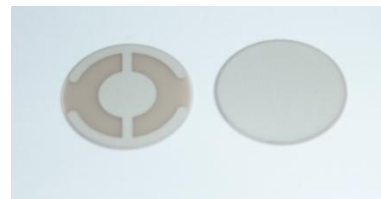
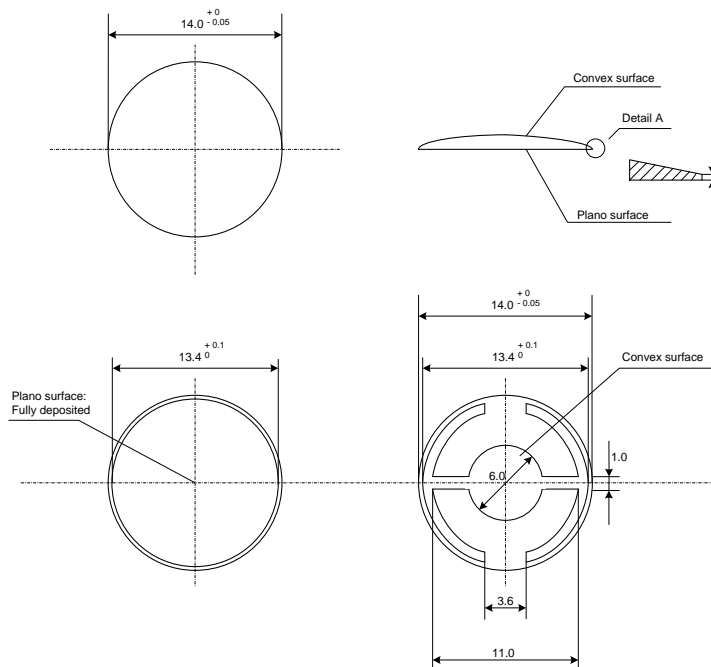

Parameter	MIN	TYP	MAX	UNIT	NOTE
Nominal frequency		5980		MHz	
Crystal cut		AT			
Diameter		14		mm	
Mode		1. overtone			
Frequency adjustment at 25°C	- 10		+ 10	KHz	
Frequency stability over temperature range	- 50		+ 50	KHz	
Resonance resistance R1		15	60	Ohm	
Operating temperature range	0°C ... + 60°C				
Storage temperature range	- 40°C ... + 105°C				
Surface	Fine lapped polished				Upon request
Electrode material	Ag Au Cr-Ag Cr-Au Al Ti Ti-Ag Ti-Au Ni				Different electrode material of side A and B upon request